



TE Enhanced Series Surface Mount

1TEC130SF8SIL/1TEC3SWSF8SIL/
1TEC2STSF8SIL/1TEC2DWSF8SIL/
1TEC3DWSF8SIL

PROJECT:	PRODUCT #:
TYPE:	COMMENTS:
PREPARED BY:	



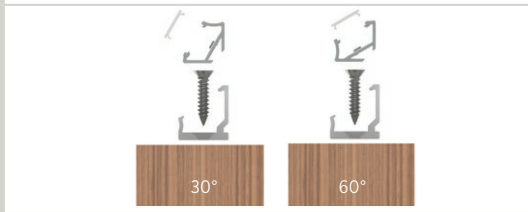
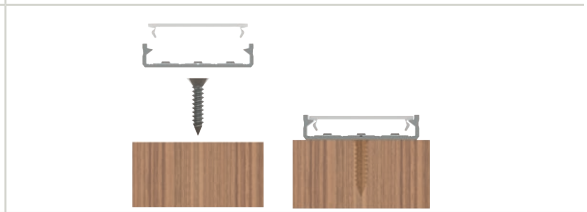
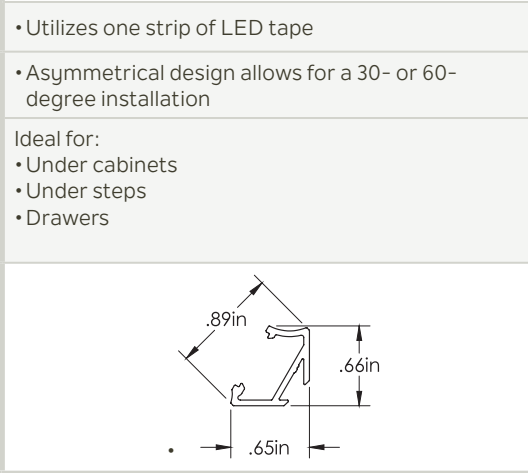
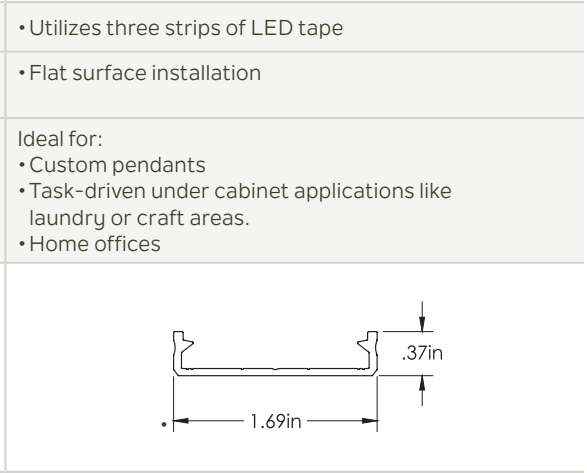
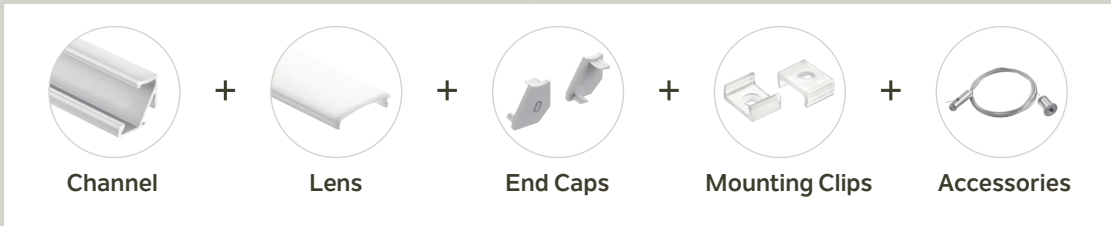



Surface Mount		
	30/60-Degree	Shallow/Wide
Channel		
Installation View		
Tape Capacity	• Utilizes one strip of LED tape	• Utilizes three strips of LED tape
Description	<ul style="list-style-type: none"> • Asymmetrical design allows for a 30- or 60-degree installation Ideal for: <ul style="list-style-type: none"> • Under cabinets • Under steps • Drawers 	<ul style="list-style-type: none"> • Flat surface installation Ideal for: <ul style="list-style-type: none"> • Custom pendants • Task-driven under cabinet applications like laundry or craft areas. • Home offices
Dimensions		
A La Carte To Build A Channel With the TE Enhanced Series, you build your own channel system. Tape Light Sold Separately.		
Channels 8ft	1TEC130SF8SIL	1TEC3SWSF8SIL
Lenses 8ft	1TEL0018WHO Flat White Opaque 1TEL0018CLR Flat Clear 1TEL1518CLR Narrow Beam Lens, Clear 1TEL3018CLR Medium Beam Lens, Clear	1TEL0038WHO 3-Tape Wide Flat Lens, White Opaque
End Caps 10 total	1TEE130SFSSIL 5 Pairs [left/right] Each with Knockout for Wires	1TEE3SWSFSSIL 5 with Wiring Hole, 5 without
Mounting Clips 10 total	1TEM130SFCLR	—
Accessories	1TEASPKSUSSIL Pendant Cable	

Compatible with Kichler Standard Output (1.5W/ft) and High Output (3W/ft) LED Tape Light.

TE Enhanced Series Surface Mount

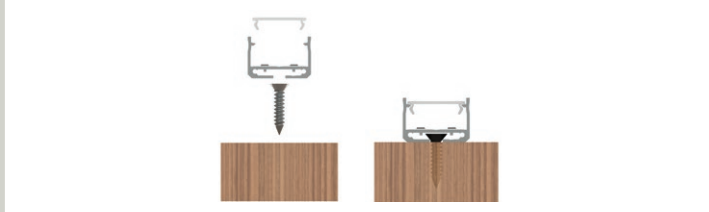
1TEC130SF8SIL/1TEC3SWSF8SIL/
1TEC2STSF8SIL/1TEC2DWSF8SIL/
1TEC3DWSF8SIL

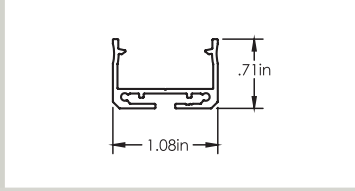
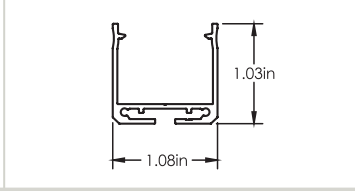
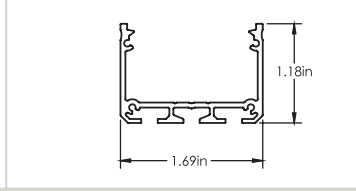
PROJECT:	PRODUCT #:
TYPE:	COMMENTS:
PREPARED BY:	

Surface Mount			
	Standard	Deep	Deep/Wide
Channel			
Installation View			
Tape Capacity	• Utilizes two strips of LED Tape		• Utilizes three strips of LED tape
Description	<ul style="list-style-type: none"> • Flat surface installation Ideal for task-driven lighting: <ul style="list-style-type: none"> • Wood beam accent • Under cabinets • Shelves • Pendants • Miter cut and connect with 1TEA Connector accessories for custom shapes (<i>See below</i>) 		
Dimensions			
A La Carte To Build A Channel With the TE Enhanced Series, you build your own channel system. Tape Light Sold Separately.	 <p style="text-align: center;"> Channel + Lens + End Caps + Accessories </p>		
Channels 8ft	1TEC2STSF8SIL	1TEC2DWSF8SIL	1TEC3DWSF8SIL
Lenses 8ft	1TEL0028WHO 2-Tape Wide Flat Lens, White Opaque		1TEL0038WHO 3-Tape Wide Flat Lens, White Opaque
End Caps 10 total	1TEE2STSFSSIL All with Knockout for Wires	1TEE2DWSFSSIL All with Knockout for Wires	1TEE3DWSFSSIL 5 with Wiring Hole, 5 without
Accessories 1 each (connectors include hex screws and hex key)	1TEA180HCONN Straight Connector Bracket 1TEA090VCONN 90° Vertical Connector Bracket 1TEA090HCONN 90° Horizontal Connector Bracket 1TEA120HCONN 120° Horizontal Connector Bracket 1TEASPKSUSSIL Pendant Cable		

Compatible with Kichler Standard Output (1.5W/ft) and High Output (3W/ft) LED Tape Light.

TE Enhanced Series

Surface Mount

1TEC130SF8SIL/1TEC3SWSF8SIL/ 1TEC2STSF8SIL/1TEC2DWSF8SIL/1TEC3DWSF8SIL



TE Enhanced Series Surface Mount

1TEC130SF8SIL/1TEC3SWSF8SIL

EXPLODED VIEW

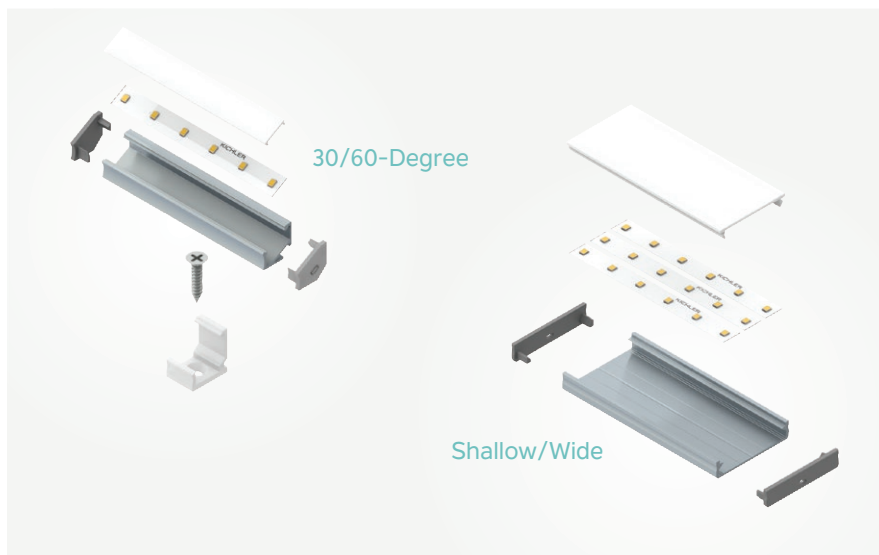

INSTALLATION VIEW



1TEC2STSF8SIL/1TEC2DWSF8SIL/1TEC3DWSF8SIL

EXPLODED VIEW

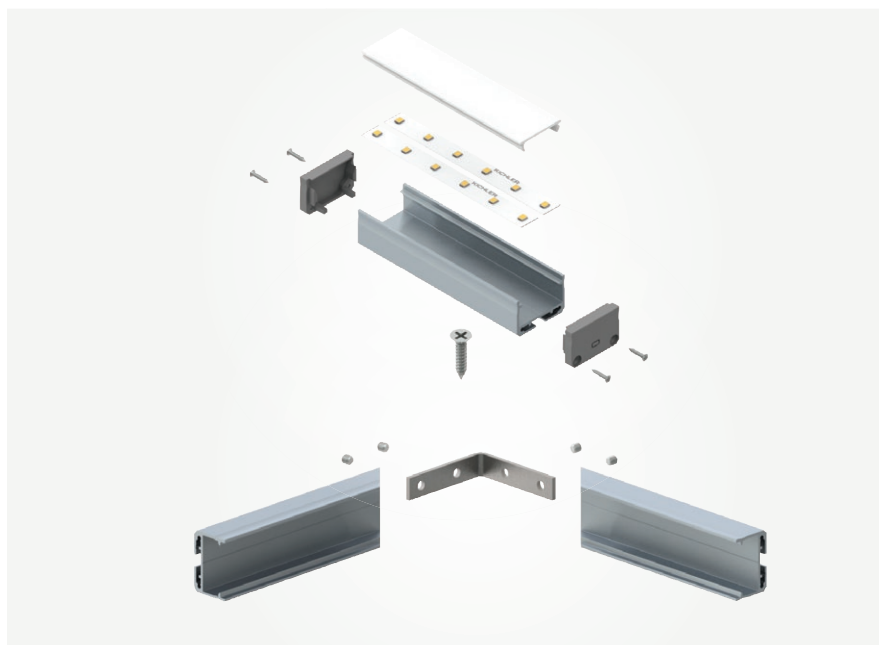

INSTALLATION VIEW



